

Description

The AP7175 is a 3.0A ultra low-dropout (LDO) linear regulator that features an enable input and a power-good output.

The enable input and power-good output allow users to configure power management solutions that can meet the sequencing requirements of FPGAs, DSPs, and other applications with different start-up and power-down requirements.

The AP7175 features two supply inputs, for power conversion supply and control. With the separation of the control and the power input very low dropout voltages can be reached and power dissipation is reduced.

A precision reference and feedback control deliver 1.5% accuracy over load, line, and operating temperature ranges.

The AP7175 is available in SO-8EP and MSOP-8EP package with an exposed PAD to reduce the junction to case resistance and extend the temperature range it can be used in.

Pin Assignments

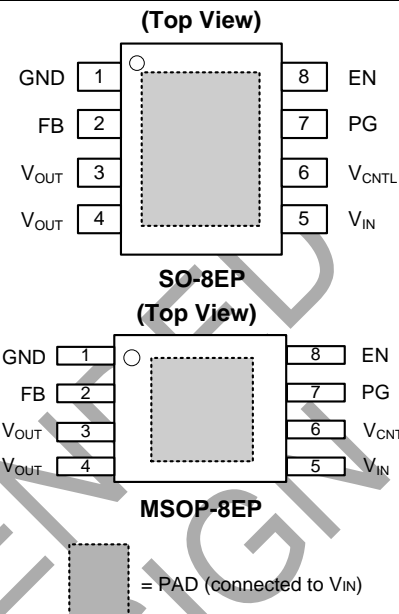

Features

- V_{IN} Range: 1.2V to 3.65V V_{CNTRL} 3.0V to 5.5V
- Adjustable output voltage
- Continuous Output Current $I_{OUT} = 3A$
- Fast transient response
- Power on reset monitoring on V_{CNTRL} and V_{IN}
- Internal Softstart
- Stable with Low ESR MLCC Capacitors
- **Totally Lead-Free & Fully RoHS Compliant (Notes 1 & 2)**
- **Halogen and Antimony Free. "Green" Device (Note 3)**

Applications

- Notebook
- PC
- Netbook
- Wireless Communication
- Server
- Motherboard
- Dongle
- Front Side Bus VTT (1.2V/3.3A)

- Notes:
1. No purposely added lead. Fully EU Directive 2002/95/EC (RoHS) & 2011/65/EU (RoHS 2) compliant.
 2. See http://www.diodes.com/quality/lead_free.html for more information about Diodes Incorporated's definitions of Halogen- and Antimony-free, "Green" and Lead-free.
 3. Halogen- and Antimony-free "Green" products are defined as those which contain <900ppm bromine, <900ppm chlorine (<1500ppm total Br + Cl) and <1000ppm antimony compounds.

Typical Applications Circuit

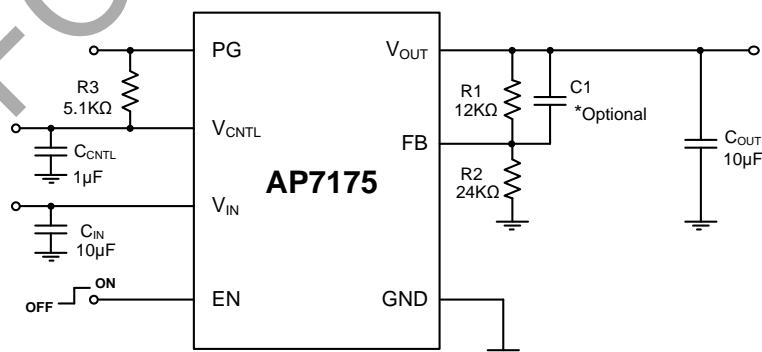
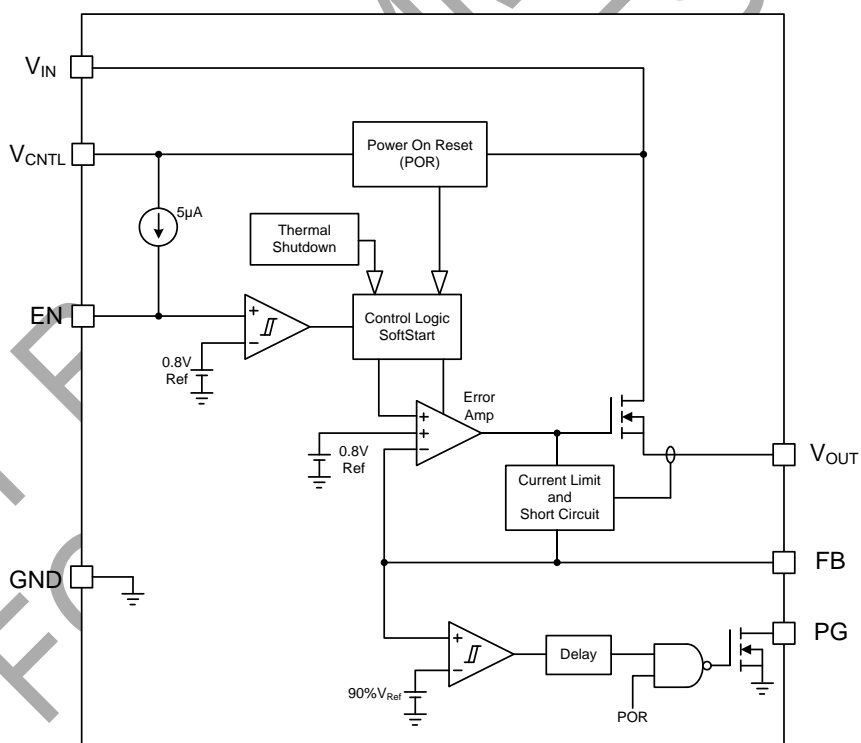

Figure 1. Typical Application Circuit

Pin Descriptions

Pin Name	Pin Number		Function
	SO-8EP	MSOP-8EP	
GND	1	1	Ground
FB	2	2	Feedback to set the output voltage via an external resistor divider between V_{OUT} and GND.
V_{OUT}	3/4	3/4	Power Output Pin. Connect at least $10\mu\text{F}$ capacitor to this pin to improve transient response and required for stability. When the part is disabled the output is discharged via an internal pull-low MOSFET.
V_{IN}	5	5	Power Input Pin for current supply. Connect a decoupling capacitor ($\geq 10\mu\text{F}$) as close as possible to the pin for noise filtering.
V_{CNTL}	6	6	BIAS supply for the controller, recommended 5V. Connect a decoupling capacitor ($\geq 1\mu\text{F}$) as close as possible to the pin for noise filtering.
PG	7	7	Power Good output open drain to indicate the status of V_{OUT} via monitoring the FB pin. This pin is pulled low when the voltage is outside the limits, during thermal shutdown and if either V_{CNTL} or V_{IN} go below their thresholds.
EN	8	8	Enable pin. Driving this pin low will disable the part. When left floating an internal current source will pull this pin high and enable it.
PAD	EP	EP	Exposed pad connect this to V_{IN} for good thermal conductivity.

Functional Block Diagram



Absolute Maximum Ratings (Note 4) (@T_A = +25°C, unless otherwise specified.)

Symbol	Parameter	Rating	Unit
V _{IN}	V _{IN} Supply Voltage (V _{IN} to GND)	-0.3 to +4.0	V
V _{CNTL}	V _{CNTL} Supply Voltage (V _{CNTL} to GND)	-0.3 to +7.0	V
V _{OUT}	V _{OUT} to GND Voltage	-0.3 to V _{IN} +0.3	V
—	PG to GND Voltage	-0.3 to +7.0	V
—	EN, FB to GND Voltage	-0.3 to V _{CNTL} +0.3	V
P _D	Power Dissipation (SO-8EP)	1.7	W
	Power Dissipation (MSOP-8EP)	1.5	W
T _J	Maximum Junction Temperature	+150	°C
T _{STG}	Storage Temperature	-65 to +150	°C
T _{SDR}	Maximum Lead Soldering Temperature, 10 Seconds	+260	°C

Note: 4. Stresses greater than the 'Absolute Maximum Ratings' specified above, may cause permanent damage to the device. These are stress ratings only; functional operation of the device at these or any other conditions exceeding those indicated in this specification is not implied. Device reliability may be affected by exposure to absolute maximum rating conditions for extended periods of time.

Recommended Operating Conditions (@T_A = +25°C, unless otherwise specified.)

Symbol	Parameter	Min	Max	Unit	
V _{CNTL}	V _{CNTL} Supply Voltage	3.0	5.5	V	
V _{IN}	V _{IN} Supply Voltage	1.2	3.65	V	
V _{OUT}	V _{OUT} Output Voltage (when V _{CNTL} -V _{OUT} > 1.9V)	0.8	V _{IN} - V _{DROP}	V	
I _{OUT}	V _{OUT} Output Current	Continuous Current	0	3	A
		Peak Current	0	4	
C _{OUT}	V _{OUT} Output Capacitance	I _{OUT} = 3A at 25% nominal V _{OUT}	8	1100	μF
		I _{OUT} = 2A at 25% nominal V _{OUT}	8	1700	
		I _{OUT} = 1A at 25% nominal V _{OUT}	8	2400	
E _{SR} C _{OUT}	ESR of V _{OUT} Output Capacitor	0	200	mΩ	
T _A	Ambient Temperature	-40	+85	°C	
T _J	Junction Temperature	-40	+125	°C	

Electrical Characteristics

($V_{CNTL} = 5V$, $V_{IN} = 1.8V$, $V_{OUT} = 1.2V$ and $T_A = -40$ to $+85^\circ C$, @ $T_A = +25^\circ C$, unless otherwise specified.)

Symbol	Parameter	Test Conditions	AP7175			Unit		
			Min	Typ	Max			
SUPPLY CURRENT								
$I_{V_{CNTL}}$	V_{CNTL} Supply Current	$EN = V_{CNTL}$, $I_{OUT}=0A$	—	1.0	1.5	mA		
I_{SD}	V_{CNTL} Supply Current at Shutdown	$EN = GND$	—	15	30	μA		
—	V_{IN} Supply Current at Shutdown	$EN = GND$, $V_{IN}=3.65V$	—	—	1	μA		
POWER-ON-RESET (POR)								
—	Rising V_{CNTL} POR Threshold	—	2.5	2.7	2.95	V		
—	V_{CNTL} POR Hysteresis	—	—	0.4	—	V		
—	Rising V_{IN} POR Threshold	—	0.8	0.9	1.0	V		
—	V_{IN} POR Hysteresis	—	—	0.5	—	V		
OUTPUT VOLTAGE								
V_{REF}	Reference Voltage	$FB = V_{OUT}$	—	0.8	—	V		
	Output Voltage Accuracy	$V_{CNTL} = 3.0V$ to $5.5V$, $I_{OUT} = 0$ to $3A$, $T_J = -40$ to $+125^\circ C$	-1.5	—	+1.5	%		
	Load Regulation	$I_{OUT} = 0A$ to $3A$	—	0.06	0.25	%		
	Line Regulation	$I_{OUT} = 10mA$, $V_{CNTL} = 3.0$ to $5.5V$	-0.15	—	+0.15	%/V		
	V_{OUT} Pull-low Resistance	$V_{CNTL} = 3.3V$, $V_{EN} = 0V$, $V_{OUT} < 0.8V$	—	10	—	Ω		
	FB Input Current	$V_{FB} = 0.8V$	-100	—	100	nA		
DROPOUT VOLTAGE								
V_{DROP}	V_{IN} -to- V_{OUT} Dropout Voltage (Note 5)	$V_{CNTL} = 5.0V$, $I_{OUT} = 3A$	$V_{OUT} = 2.5V$	$T_J = +25^\circ C$	—	0.26	0.31	V
				$T_J = -40$ to $+125^\circ C$	—	—	0.42	
			$V_{OUT} = 1.8V$	$T_J = +25^\circ C$	—	0.24	0.29	
				$T_J = -40$ to $+125^\circ C$	—	—	0.40	
$V_{OUT} = 1.2V$	$T_J = +25^\circ C$	—	0.23	0.28				
	$T_J = -40$ to $+125^\circ C$	—	—	0.38				
I_{LIM}	Current-Limit Level	$T_J = +25^\circ C$, $V_{OUT} = 80\% V_{NOMINAL}$ $T_J = -40$ to $+125^\circ C$	$T_J = +25^\circ C$	4.5	5.7	6.7	A	
			$T_J = -40$ to $+125^\circ C$	4.2	—	—	A	
PROTECTIONS								
I_{SHORT}	Short Current-Limit Level	$V_{FB} < 0.2V$	—	1.1	—	A		
T_{SD}	Thermal Shutdown Temperature	T_J rising	—	+170	—	$^\circ C$		
—	Thermal Shutdown Hysteresis	—	—	+50	—	$^\circ C$		
ENABLE AND SOFT-START								
—	EN Logic High Threshold Voltage	V_{EN} rising	0.5	0.8	1.1	V		
—	EN Hysteresis	—	—	0.1	—	V		
—	EN Pull-High Current	$EN = GND$	—	5	—	μA		
t_{SS}	Soft-Start Interval	—	0.3	0.6	1.2	ms		
—	Turn On Delay	From being enabled to V_{OUT} rising 10%	200	350	500	μs		
POWER-GOOD AND DELAY								
V_{THPG}	Rising PG Threshold Voltage	V_{FB} rising	90	92	95	%		
—	PG Threshold Hysteresis	—	—	8	—	%		
—	PG Pull-low Voltage	PG sinks 5mA	—	0.25	0.4	V		
—	PG Debounce Interval	$V_{FB} <$ falling PG voltage threshold	—	10	—	μs		
—	PG Delay Time	From $V_{FB} = V_{THPG}$ to rising edge of the V_{PG}	1	2	4	ms		

Note: 5. Dropout voltage is the voltage difference between the input and the output at which the output voltage drops 2% below its nominal value.

Electrical Characteristics (Cont.)

($V_{CNTL} = 5V$, $V_{IN} = 1.8V$, $V_{OUT} = 1.2V$ and $T_A = -40$ to $+85^\circ C$, @ $T_A = +25^\circ C$, unless otherwise specified.)

Symbol	Parameter	Test Conditions	AP7175			Unit
			Min	Typ	Max	
THERMAL CHARACTERISTIC						
θ_{JA}	Thermal Resistance Junction-to-Ambient	SO-8EP (Note 6)	—	70	—	$^\circ C/W$
		MSOP-8EP (Note 7)	—	80	—	$^\circ C/W$
θ_{JC}	Thermal Resistance Junction-to-Case	SO-8EP (Note 6)	—	30	—	$^\circ C/W$
		MSOP-8EP (Note 7)	—	30	—	$^\circ C/W$

Notes: 6. Device mounted on 2"×2" FR-4 substrate PC board, 2oz copper, with minimum recommended pad on top layer and thermal vias to bottom layer ground plane.
7. Device mounted on 2"×2" FR-4 substrate PC board, 2oz copper, with minimum recommended pad layout.

Typical Characteristics

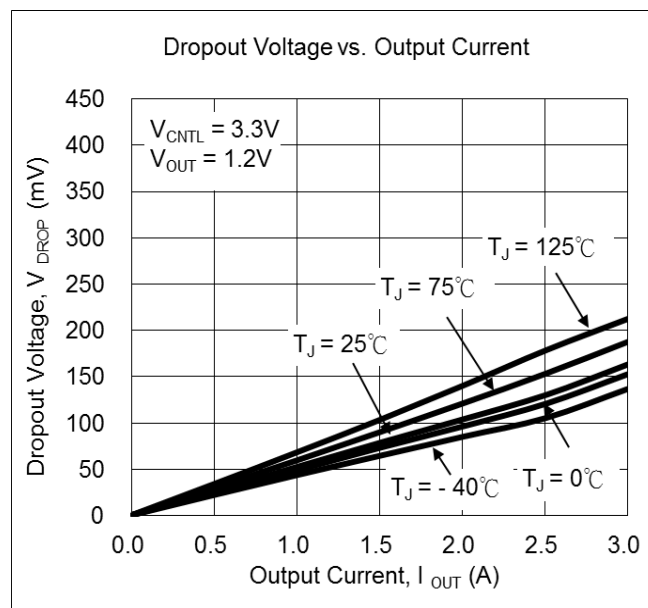
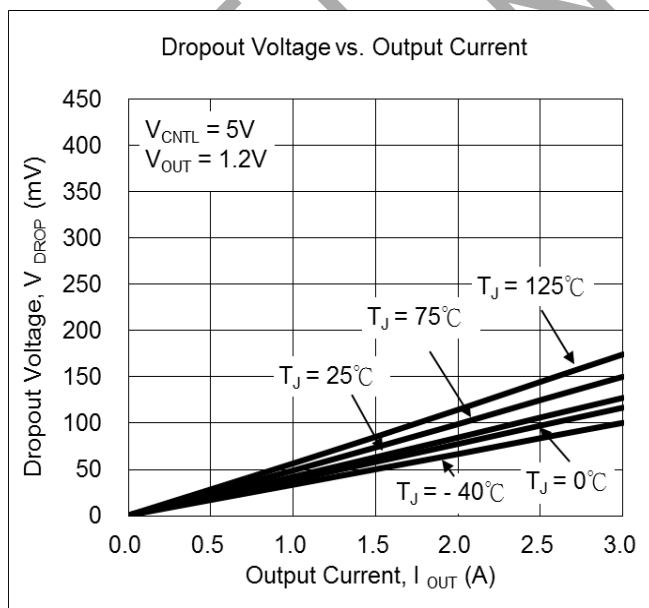
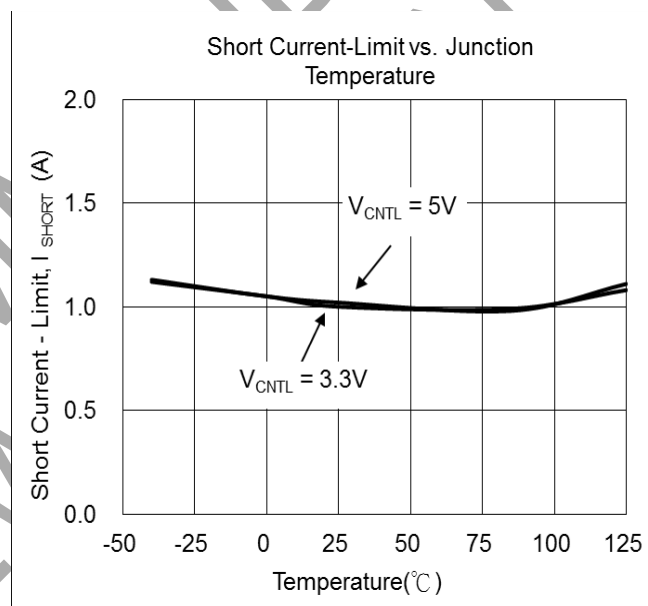
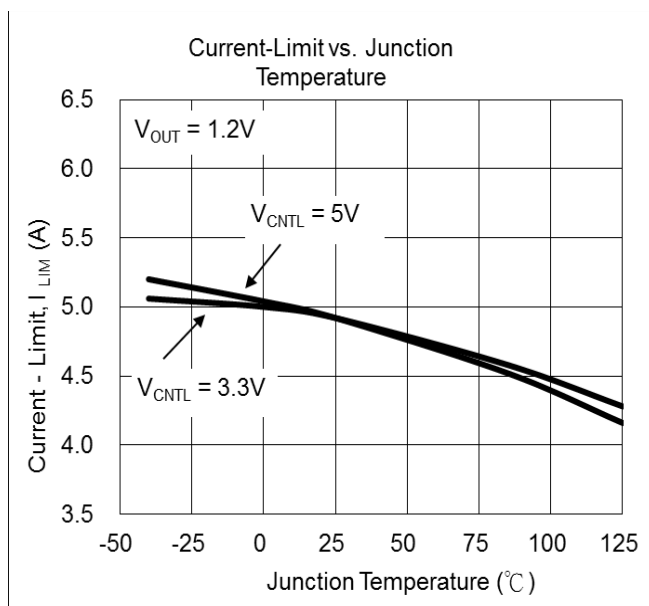

Typical Characteristics (Cont.)

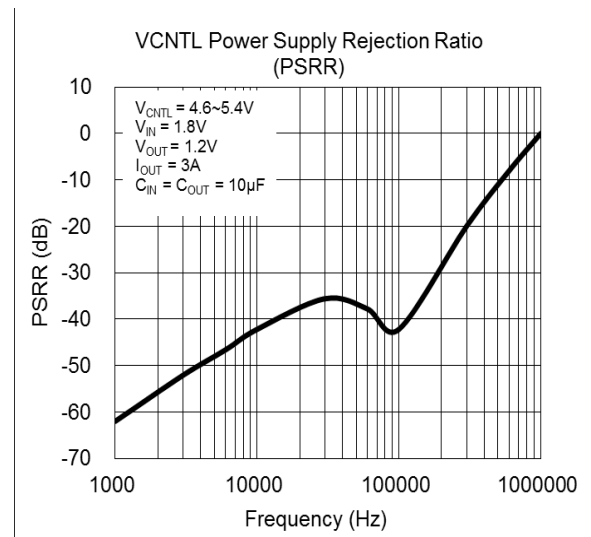
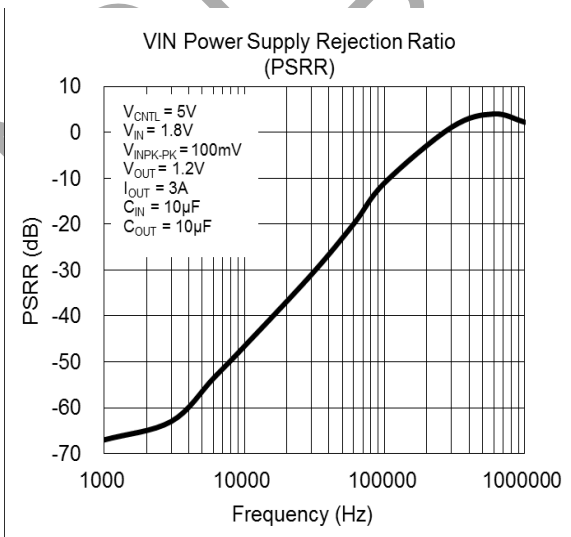
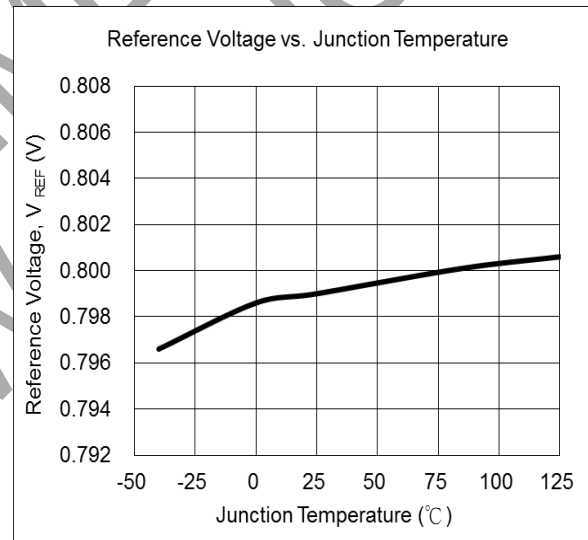
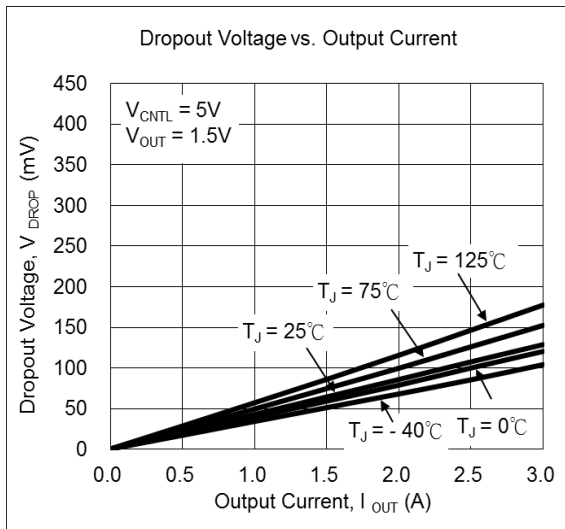
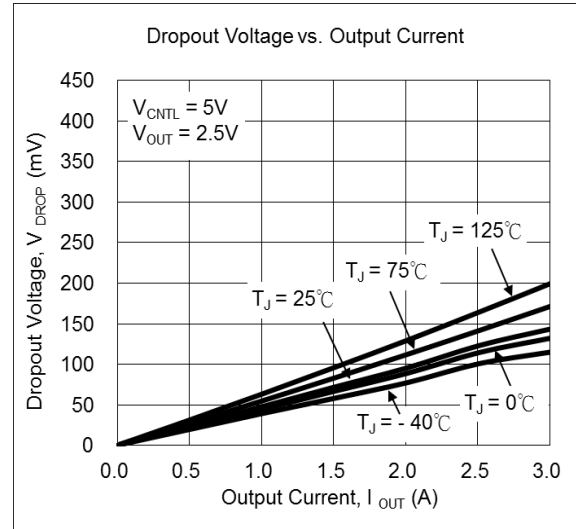
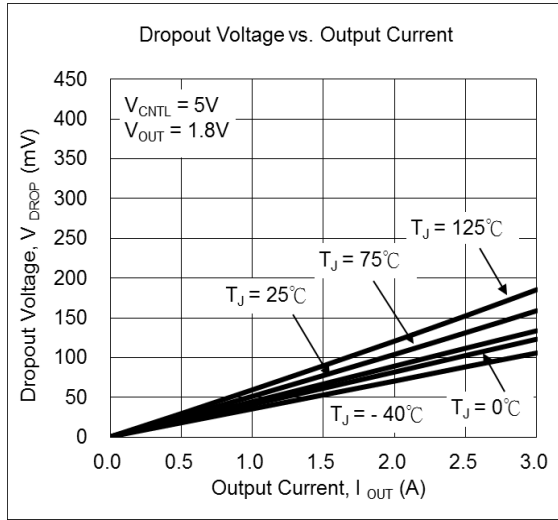

Operating Waveforms (@ $V_{CNTL} = 5V$, $V_{IN} = 1.8V$, $V_{OUT} = 1.2V$, $T_A = +25^\circ C$, unless otherwise specified.)

Power On

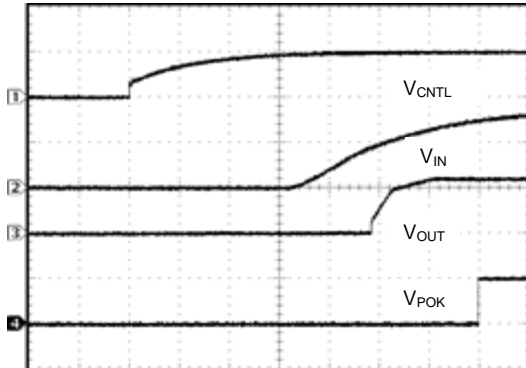

$C_{OUT}=10\mu F$, $C_{IN}=10\mu F$, $R_L=0.4\Omega$
 CH1: V_{CNTL} , 5V/Div, DC
 CH2: V_{IN} , 1V/Div, DC
 CH3: V_{OUT} , 1V/Div, DC
 CH4: V_{POK} , 5V/Div, DC
 TIME: 2ms/Div

Power Off

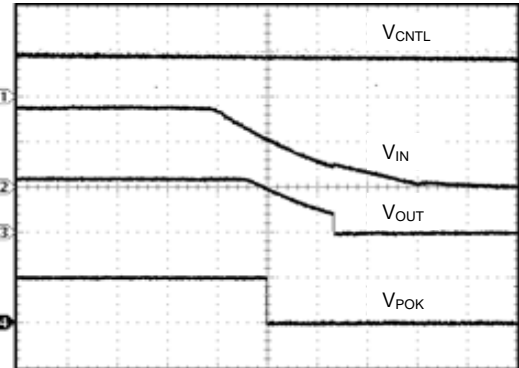

$C_{OUT}=10\mu F$, $C_{IN}=10\mu F$, $R_L=0.4\Omega$
 CH1: V_{CNTL} , 5V/Div, DC
 CH2: V_{IN} , 1V/Div, DC
 CH3: V_{OUT} , 1V/Div, DC
 CH4: V_{POK} , 5V/Div, DC
 TIME: 2ms/Div

Load Transient Response

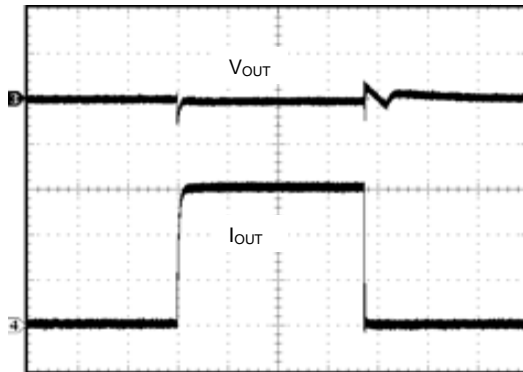

$I_{OUT} = 10mA$ to 3A to 10mA (rise / fall time = 1 μs)
 $C_{OUT} = 10\mu F$, $C_{IN} = 10\mu F$
 CH1: V_{OUT} , 50mV/Div, AC
 CH2: I_{OUT} , 1A/Div, DC
 TIME: 50 μs /Div

Over Current Protection

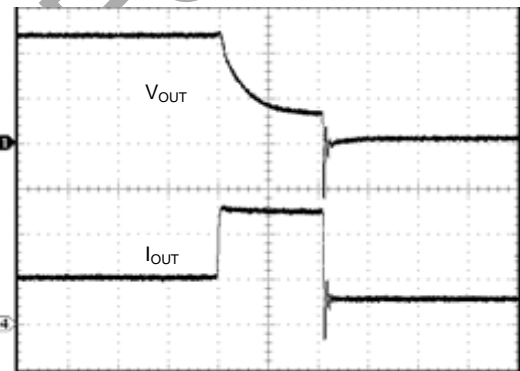

$C_{OUT} = 10\mu F$, $C_{IN} = 10\mu F$, $I_{OUT} = 2A$ to 5.6A
 CH1: V_{OUT} , 0.5V/Div, DC
 CH2: I_{OUT} , 2A/Div, DC
 TIME: 0.2ms/Div

Operating Waveforms (Cont.) (@ $V_{CNTL} = 5V$, $V_{IN} = 1.8V$, $V_{OUT} = 1.2V$, $T_A = +25^\circ C$, unless otherwise specified.)

Shutdown

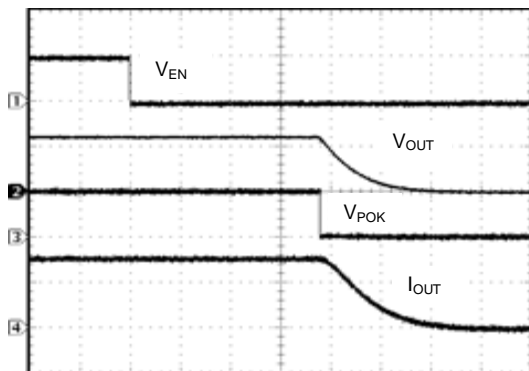

$C_{OUT} = 10\mu F$, $C_{IN} = 10\mu F$, $R_L = 0.4\Omega$
 CH1: V_{EN} , 5V/Div, DC
 CH2: V_{OUT} , 1V/Div, DC
 CH3: V_{POK} , 5V/Div, DC
 CH4: I_{OUT} , 2A/Div, DC
 TIME: 4 μ s/Div

Enable

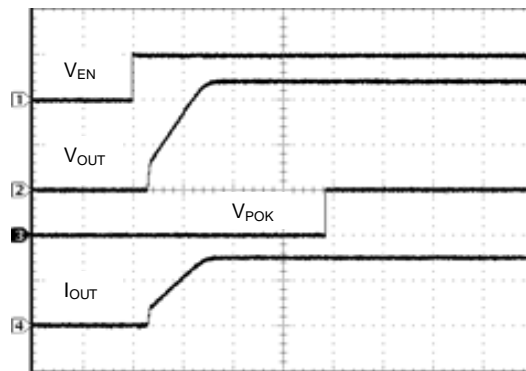

$C_{OUT} = 10\mu F$, $C_{IN} = 10\mu F$, $R_L = 0.4\Omega$
 CH1: V_{EN} , 5V/Div, DC
 CH2: V_{OUT} , 1V/Div, DC
 CH3: V_{POK} , 5V/Div, DC
 CH4: I_{OUT} , 2A/Div, DC
 TIME: 1ms/Div

NOT RECOMMENDED FOR NEW DESIGN

Application Information

Power Good and Delay

AP7175 monitors the feedback voltage V_{FB} on the FB pin. An internal delay timer is started after the PG voltage threshold (V_{THPG}) on the FB pin is reached. At the end of the delay time an internal NMOS of the PG is turned off to indicate that the power at the output is good (PG). This monitoring function is continued during operation and if V_{FB} falls 8% (typ) below V_{THPG} , the NMOS of the PG is turned on after a delay time of typical 10 μ s to avoid oscillating of the PG signal.

Power On Reset

AP7175 monitors both supply voltages, V_{CNTL} and V_{IN} to ensure operation as intended. A Soft-Start process is initiated after both voltages exceed their POR threshold during power on. During operation the POR component continues to monitor the supply voltage and pulls the PG low to indicate an out of regulation supply. This function will engage without regard to the status of the output.

Soft-Start

AP7175 incorporates an internal Soft-Start function. The output voltage rise is controlled to limit the current surge during start-up. The typical Soft-Start time is 0.6ms.

Current-Limit Protection

AP7175 monitors the current flow through the NMOS and limits the maximum current to avoid damage to the load and AP7175 during overload conditions.

Short Circuit Current-Limit Protection

AP7175 incorporates a current limit function to reduce the maximum current to 1.1A (typ) when the voltage at FB falls below 0.2V (typ) during an overload or short circuit situation.

During start-up period, this function is disabled to ensure successful heavy load start-up.

Enable Control

If the enable pin (EN) is left open, an internal current source of $\sim 5\mu$ A pulls the pin up and enables the AP7175. This will reduce the bill of material saving an external pull up resistor. Driving the enable pin low disables the device. Driving the pin high subsequently initiates a new Soft-Start cycle.

Output Voltage Regulation

Output Voltage is set by resistor divider from V_{OUT} via FB pin to GND. Internally V_{FB} is compared to a 0.8V temperature compensated reference voltage and the NMOS pass element regulates the output voltage while delivering current from V_{IN} to V_{OUT} .

Setting the Output Voltage

A resistor divider connected to FB pin programs the output voltage.

$$V_{OUT} = V_{REF} * \left(1 + \frac{R1}{R2}\right) V$$

R1 is connected from V_{OUT} to FB with Kelvin sensing connection. R2 is connected from FB to GND. To improve load transient response and stability, a bypass capacitor can be connected in parallel with R1. (optional in typical application circuit)

Power Sequencing

AP7175 requires no specific sequencing between V_{IN} and V_{CNTL} . However, care should be taken to avoid forcing V_{OUT} for prolonged time without the presence of V_{IN} . Conduction through internal parasitic diode (from V_{OUT} to V_{IN}) could damage AP7175.

Thermal Shutdown

The PCB layout and power requirements for AP7175 under normal operation condition should allow enough cooling to restrict the junction temperature to $+125^{\circ}\text{C}$. The packages for AP7175 have an exposed PAD to support this. These packages provide better connection to the PCB and thermal performance. Refer to the layout considerations.

If AP7175 junction temperature reaches $+170^{\circ}\text{C}$ a thermal protection block disables the NMOS pass element and lets the part cool down. After its junction temperature drops by 50°C (typ), a new Soft-Start cycle will be initiated. A new thermal protection will start, if the load or ambient conditions continue to raise the junction temperature to $+170^{\circ}\text{C}$. This cycle will repeat until normal operation temperature is maintained again.

Application Information (Cont.)

Output Capacitor

An output capacitor (C_{OUT}) is needed to improve transient response and maintain stability. The ESR (equivalent series resistance) and capacitance drives the selection. Care needs to be taken to cover the entire operating temperature range.

The output capacitor can be an Ultra-Low-ESR ceramic chip capacitor or a low ESR bulk capacitor like a solid tantalum, POSCap or aluminum electrolytic capacitor.

C_{OUT} is used to improve the output stability and reduces the changes of the output voltage during load transitions. The slew rate of the current sensed via the FB pin in AP7175 is reduced. If the application has large load variations, it is recommended to utilize low-ESR bulk capacitors.

It is recommended to place ceramic capacitors as close as possible to the load and the ground pin and care should be taken to reduce the impedance in the layout.

Input Capacitor

To prevent the input voltage from dropping during load steps it is recommended to utilize an input capacitor (C_{IN}). As with the output capacitor the following are acceptable, Ultra-Low-ESR ceramic chip capacitor or low ESR bulk capacitor like a solid tantalum, POSCap or aluminum electrolytic capacitor. Typically it is recommended to utilize a capacitance of at least $10\mu\text{F}$ to avoid output voltage drop due to reduced input voltage. The value can be lower if V_{IN} changes are not critical for the application.

Layout Considerations

For good ground loop and stability, the input and output capacitors should be located close to the input, output, and ground pins of the device. No other application circuit is connected within the loop. Avoid using vias within ground loop. If vias must be used, multiple vias should be used to reduce via inductance.

The regulator ground pin should be connected to the external circuit ground to reduce voltage drop caused by trace impedance. Ground plane is generally used to reduce trace impedance.

Wide trace should be used for large current paths from V_{IN} to V_{OUT} , and load circuit.

Place the R1, R2, and C1 (optional) near the LDO as close as possible to avoid noise coupling.

R2 is placed close to device ground. Connect the ground of the R2 to the GND pin by using a dedicated trace.

Connect the pin of the R1 directly to the load for Kelvin sensing.

No high current should flow through the ground trace of feedback loop and affect reference voltage stability.

For the packages with exposed pads, heat sinking is accomplished using the heat spreading capability of the PCB and its copper traces. Suitable PCB area on the top layer and thermal vias (0.3mm drill size with 1mm spacing, 4-8 vias at least) to the V_{in} power plane can help to reduce device temperature greatly.

Reference Layout Plots

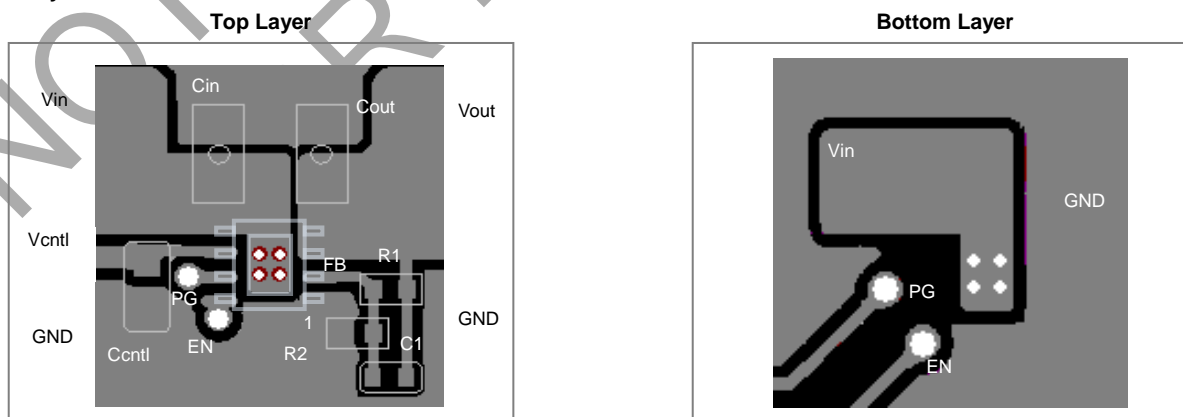

Ordering Information

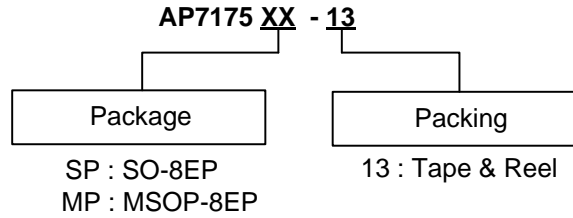

Part Number	Package Code	Packaging	13" Tape and Reel	
			Quantity	Part Number Suffix
AP7175SP-13	SP	SO-8EP	2500/Tape & Reel	-13
AP7175MP-13	MP	MSOP-8EP	2500/Tape & Reel	-13

Marking Information

(1) SO-8EP

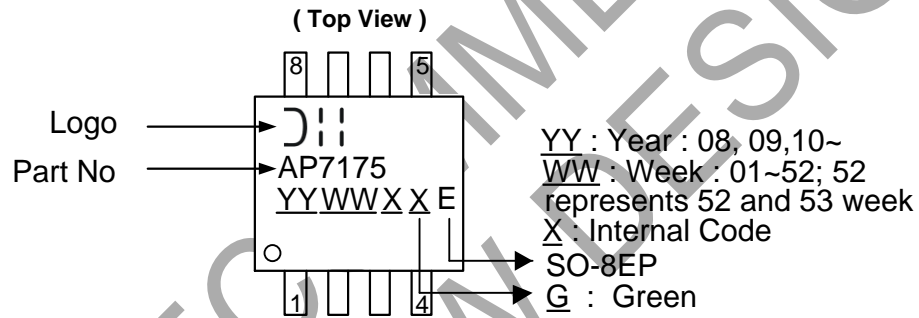

(2) MSOP-8EP

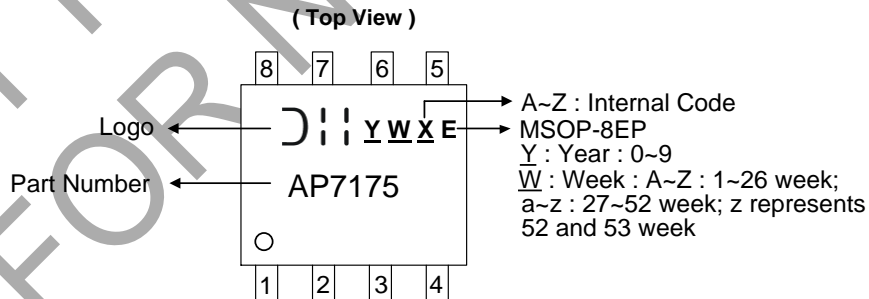

Package Outline Dimensions

Please see <http://www.diodes.com/package-outlines.html> for the latest version.

(1) SO-8EP

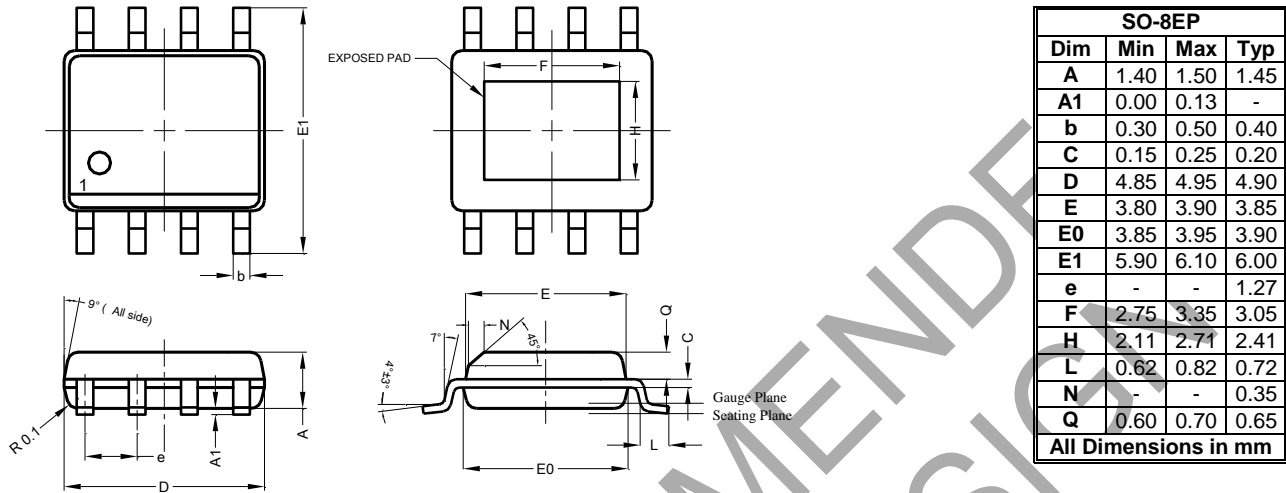

(2) MSOP-8EP

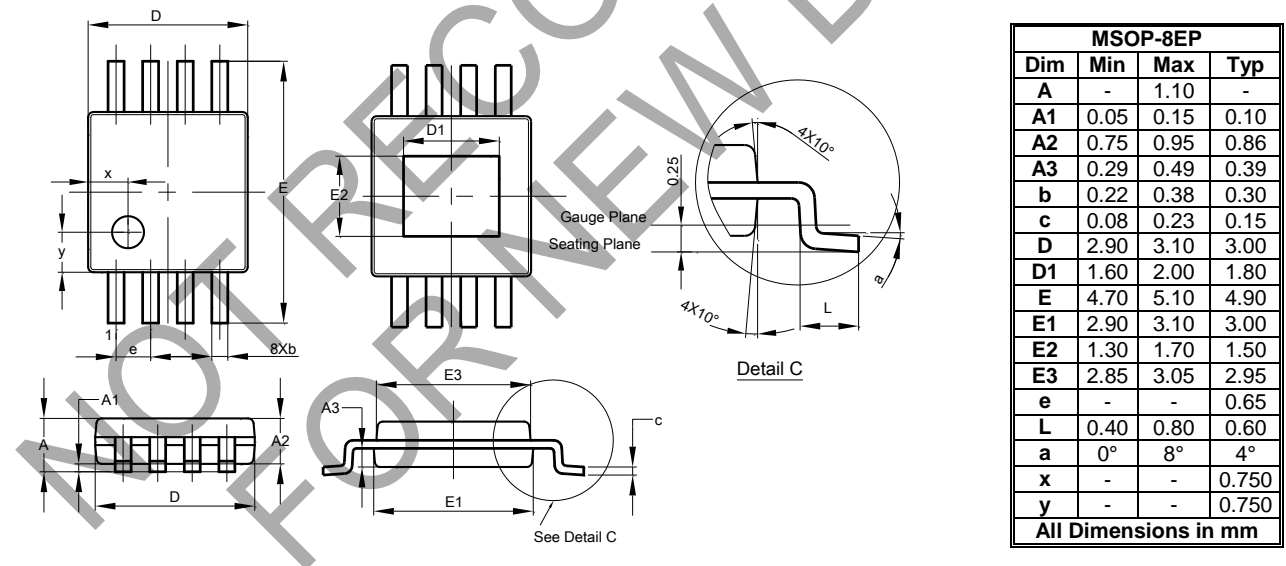

Suggested Pad Layout

Please see <http://www.diodes.com/package-outlines.html> for the latest version.

(1) SO-8EP

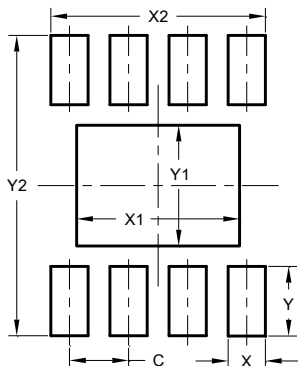

Dimensions	Value (in mm)
C	1.270
X	0.802
X1	3.502
X2	4.612
Y	1.505
Y1	2.613
Y2	6.500

(2) MSOP-8EP

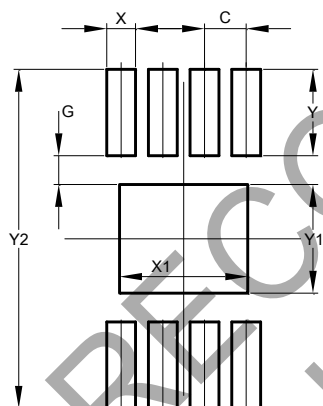

Dimensions	Value (in mm)
C	0.650
G	0.450
X	0.450
X1	2.000
Y	1.350
Y1	1.700
Y2	5.300

IMPORTANT NOTICE

DIODES INCORPORATED MAKES NO WARRANTY OF ANY KIND, EXPRESS OR IMPLIED, WITH REGARDS TO THIS DOCUMENT, INCLUDING, BUT NOT LIMITED TO, THE IMPLIED WARRANTIES OF MERCHANTABILITY AND FITNESS FOR A PARTICULAR PURPOSE (AND THEIR EQUIVALENTS UNDER THE LAWS OF ANY JURISDICTION).

Diodes Incorporated and its subsidiaries reserve the right to make modifications, enhancements, improvements, corrections or other changes without further notice to this document and any product described herein. Diodes Incorporated does not assume any liability arising out of the application or use of this document or any product described herein; neither does Diodes Incorporated convey any license under its patent or trademark rights, nor the rights of others. Any Customer or user of this document or products described herein in such applications shall assume all risks of such use and will agree to hold Diodes Incorporated and all the companies whose products are represented on Diodes Incorporated website, harmless against all damages.

Diodes Incorporated does not warrant or accept any liability whatsoever in respect of any products purchased through unauthorized sales channel. Should Customers purchase or use Diodes Incorporated products for any unintended or unauthorized application, Customers shall indemnify and hold Diodes Incorporated and its representatives harmless against all claims, damages, expenses, and attorney fees arising out of, directly or indirectly, any claim of personal injury or death associated with such unintended or unauthorized application.

Products described herein may be covered by one or more United States, international or foreign patents pending. Product names and markings noted herein may also be covered by one or more United States, international or foreign trademarks.

This document is written in English but may be translated into multiple languages for reference. Only the English version of this document is the final and determinative format released by Diodes Incorporated.

LIFE SUPPORT

Diodes Incorporated products are specifically not authorized for use as critical components in life support devices or systems without the express written approval of the Chief Executive Officer of Diodes Incorporated. As used herein:

A. Life support devices or systems are devices or systems which:

1. are intended to implant into the body, or
2. support or sustain life and whose failure to perform when properly used in accordance with instructions for use provided in the labeling can be reasonably expected to result in significant injury to the user.

B. A critical component is any component in a life support device or system whose failure to perform can be reasonably expected to cause the failure of the life support device or to affect its safety or effectiveness.

Customers represent that they have all necessary expertise in the safety and regulatory ramifications of their life support devices or systems, and acknowledge and agree that they are solely responsible for all legal, regulatory and safety-related requirements concerning their products and any use of Diodes Incorporated products in such safety-critical, life support devices or systems, notwithstanding any devices- or systems-related information or support that may be provided by Diodes Incorporated. Further, Customers must fully indemnify Diodes Incorporated and its representatives against any damages arising out of the use of Diodes Incorporated products in such safety-critical, life support devices or systems.

Copyright © 2017, Diodes Incorporated

www.diodes.com